

# U-20LHREC Model-SN 7554 and higher

OUTLINE OF THE INSTALLED UNIT

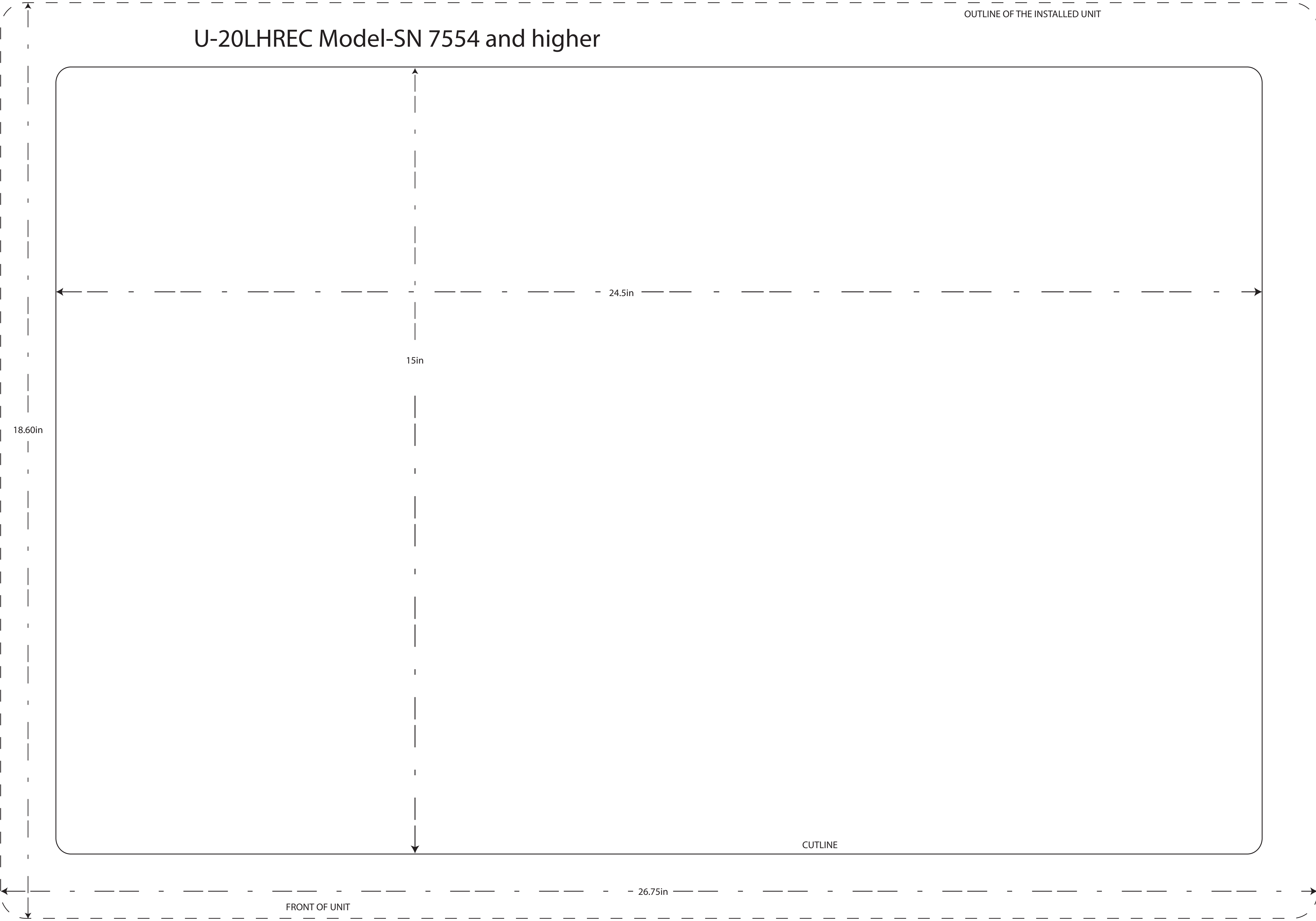

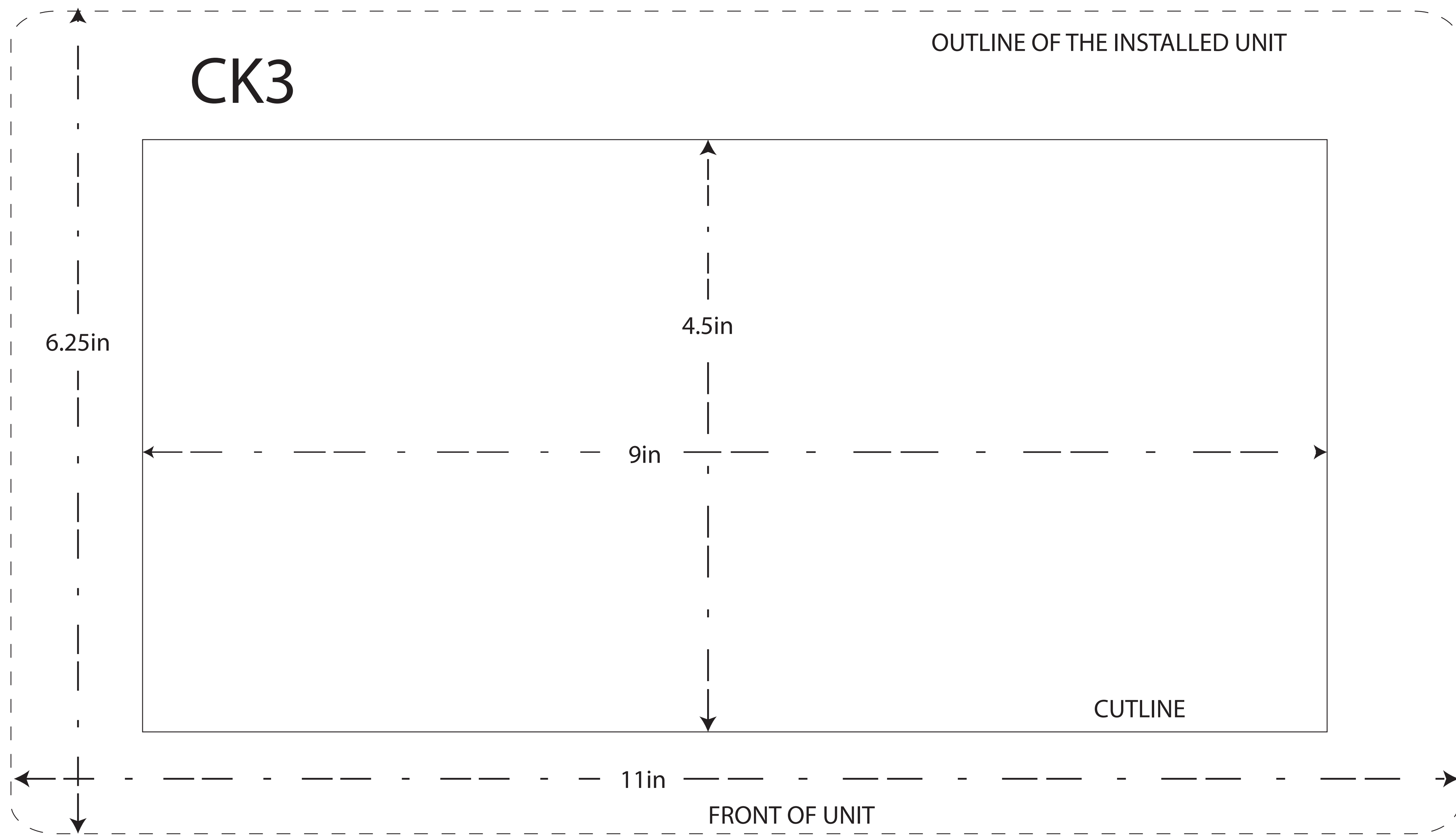

# Front View

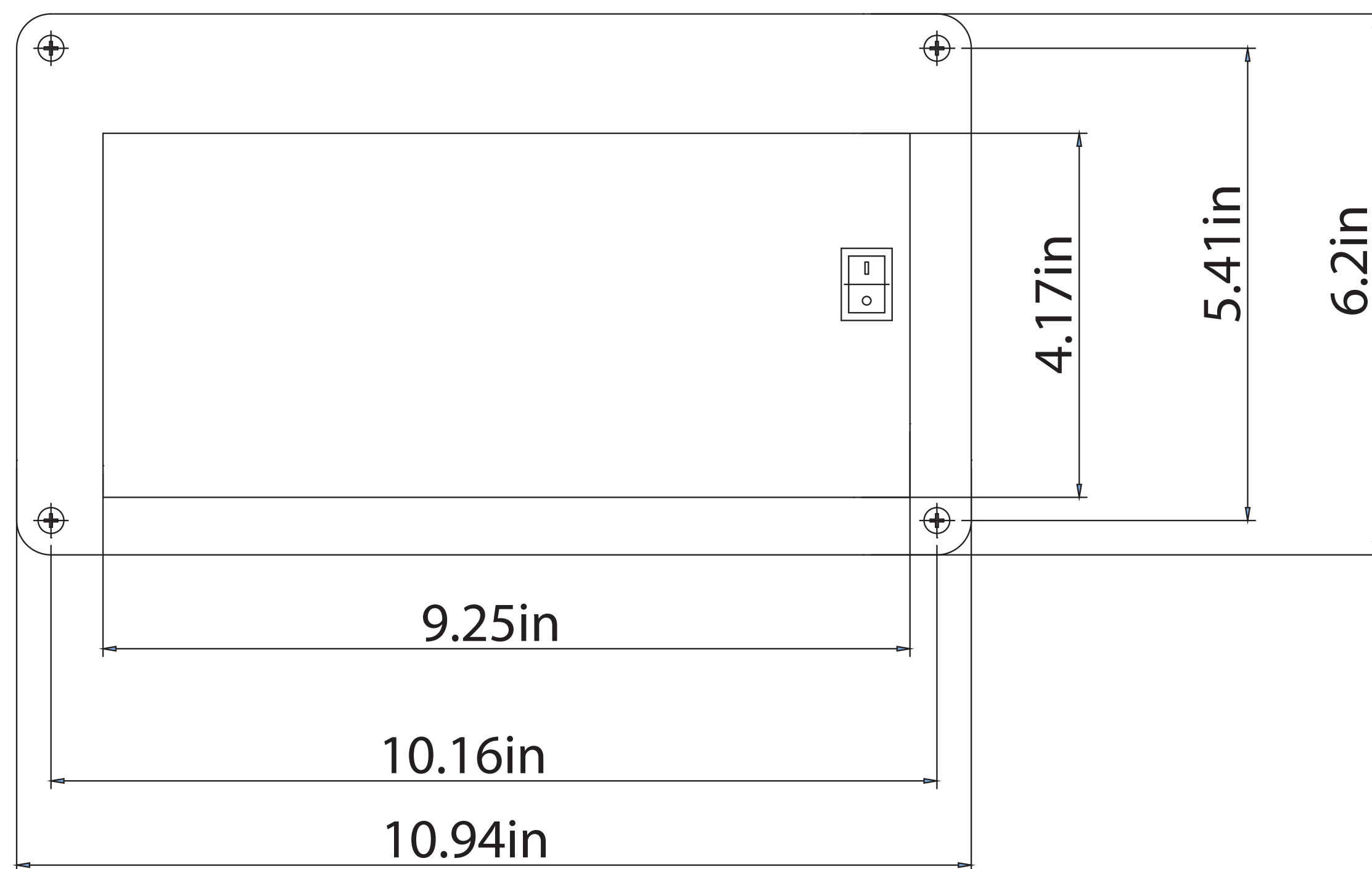

# Top View

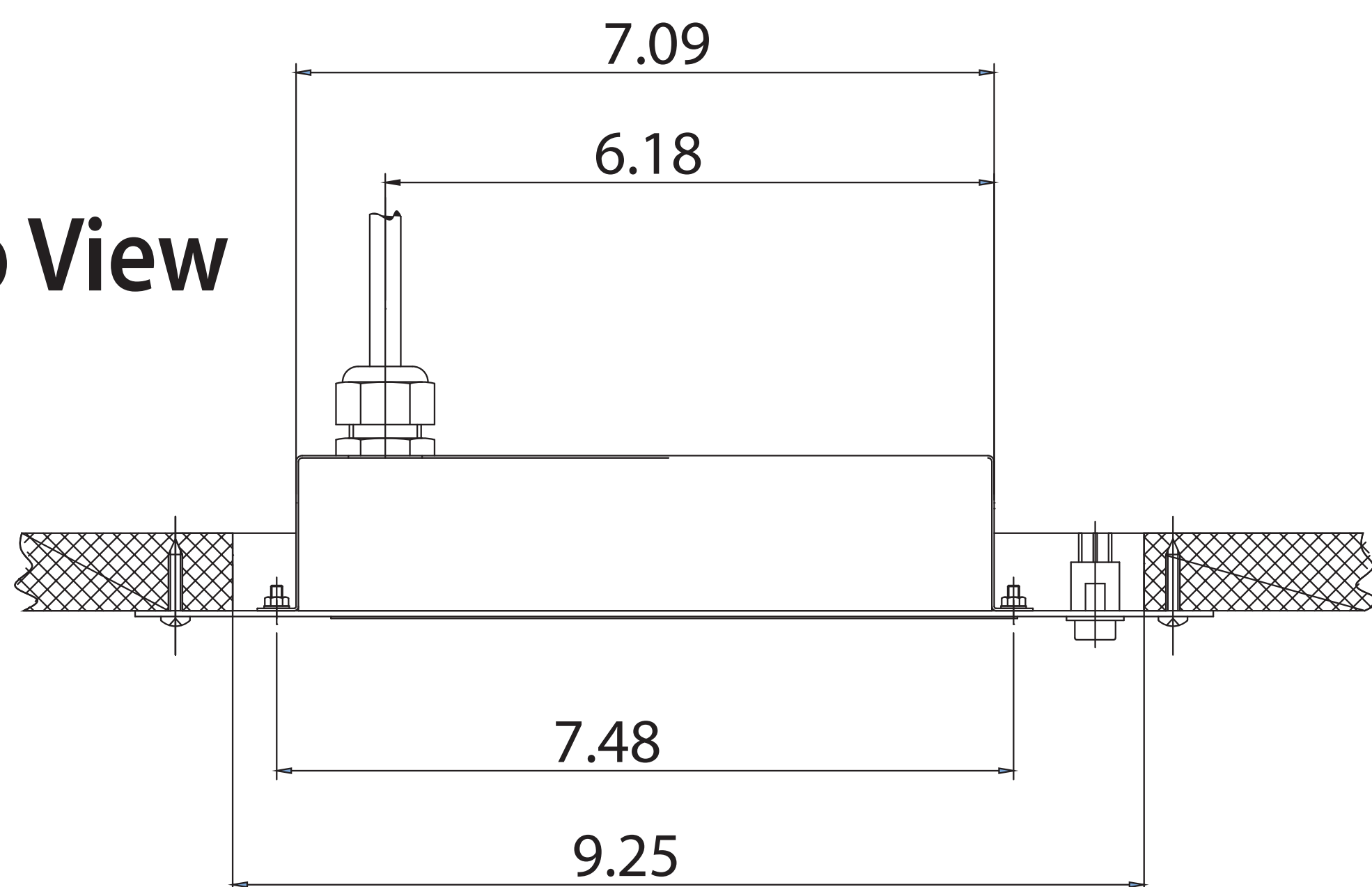

# Right Side View

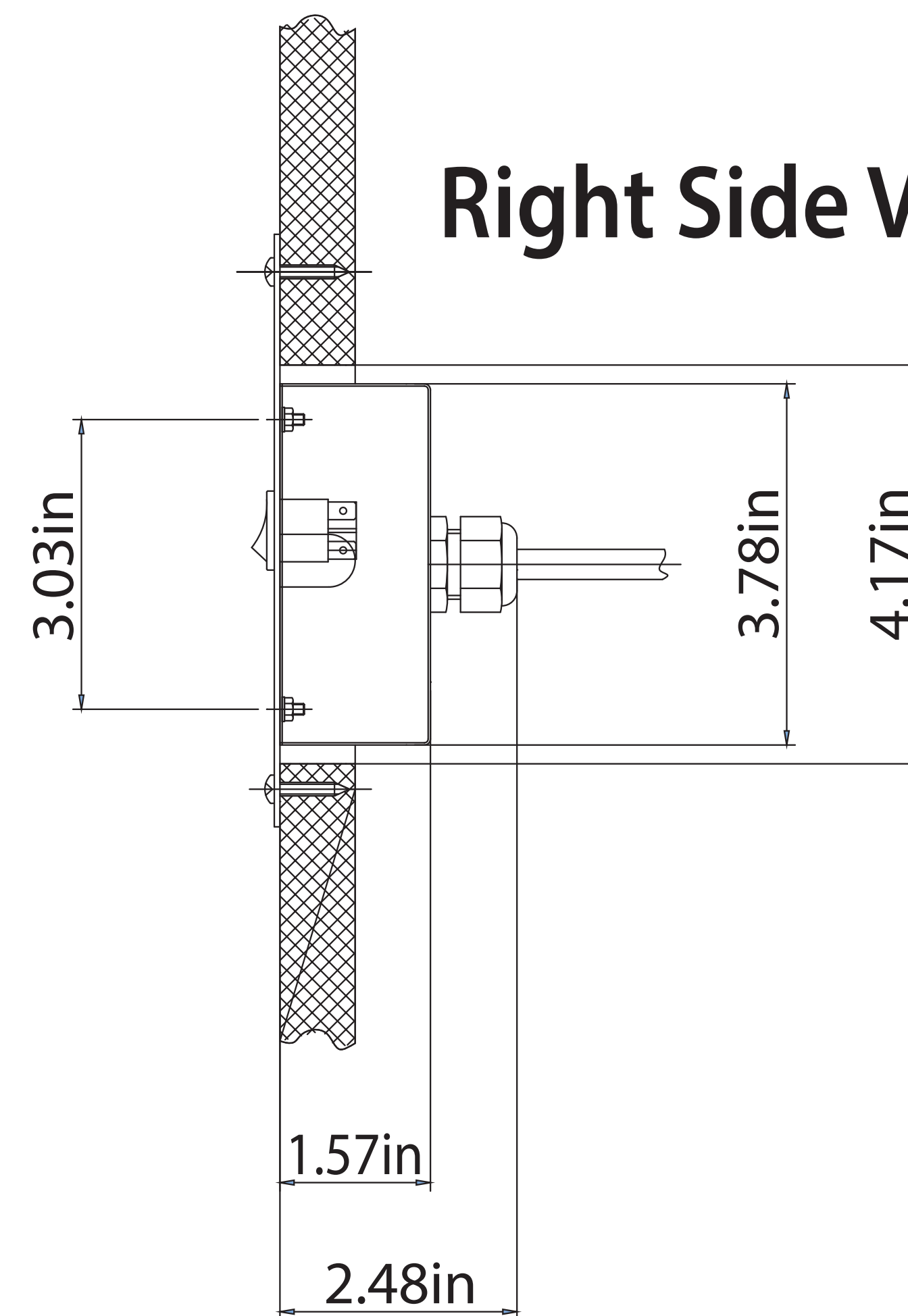

**Front View**

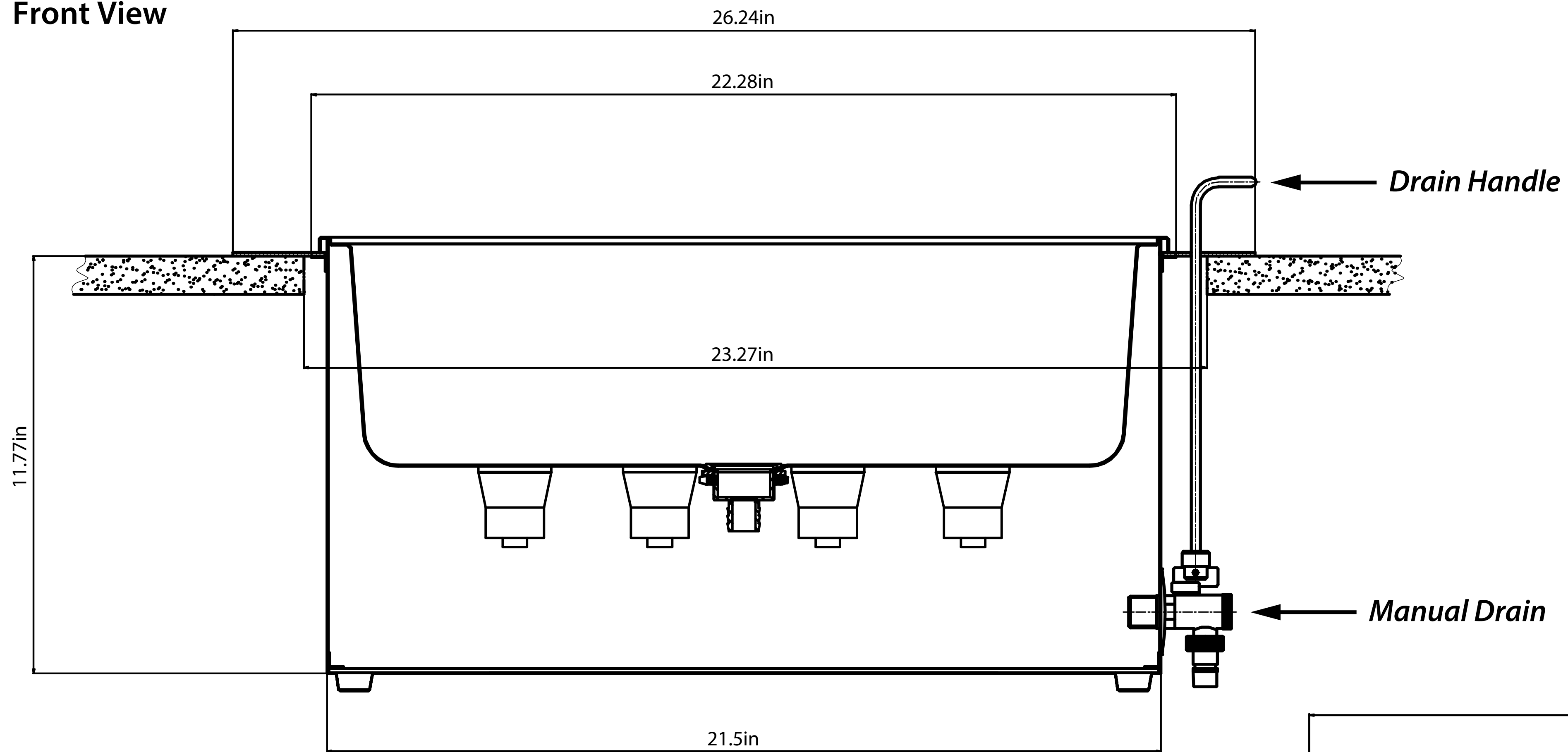

**Top View**

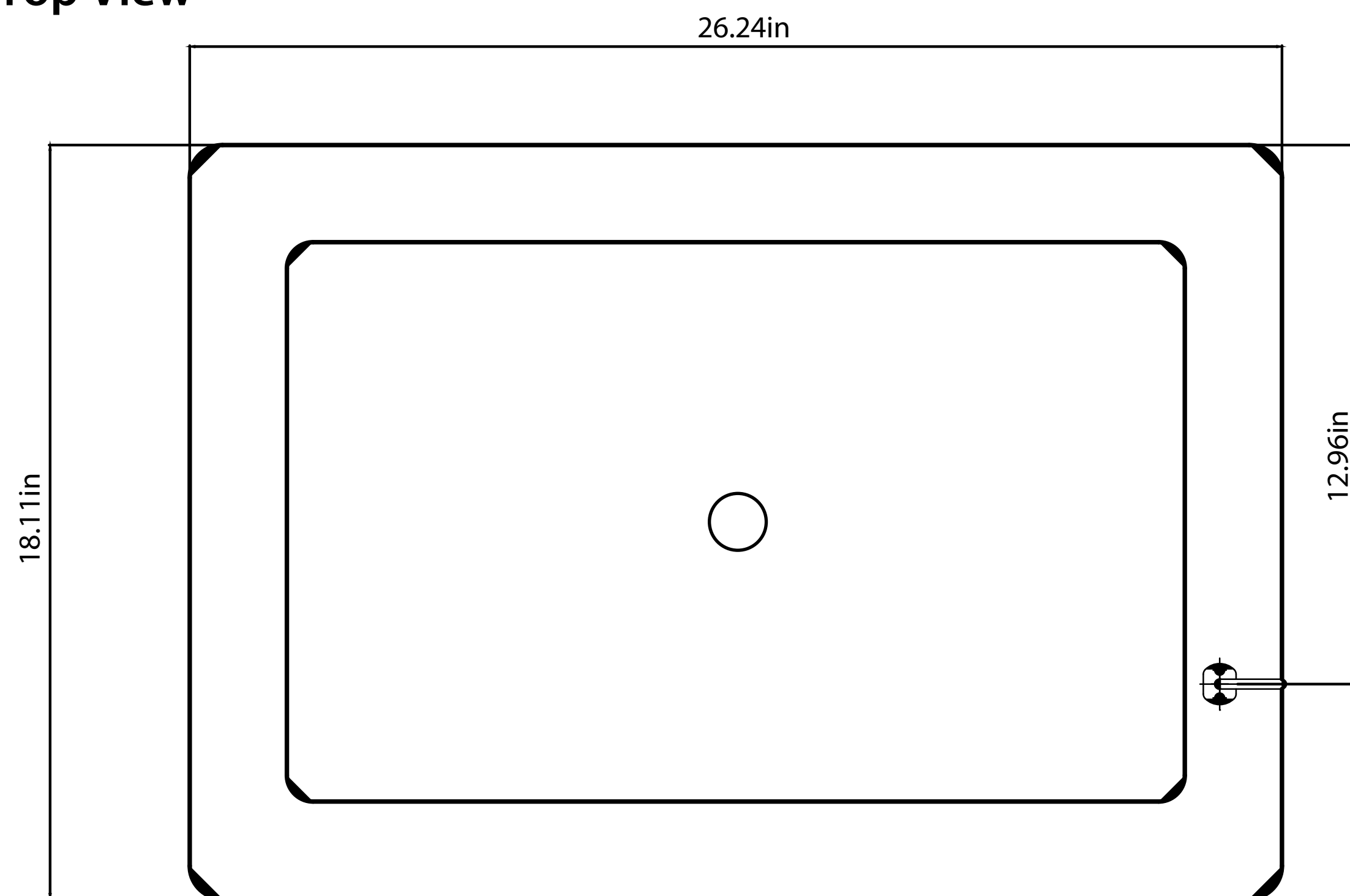

**Right Side View**

